

Article datasheet

Swage Standoff $\text{\O}4.2 \times 6.0$ Tin-Plated Steel

Article-No.: 004.61.835

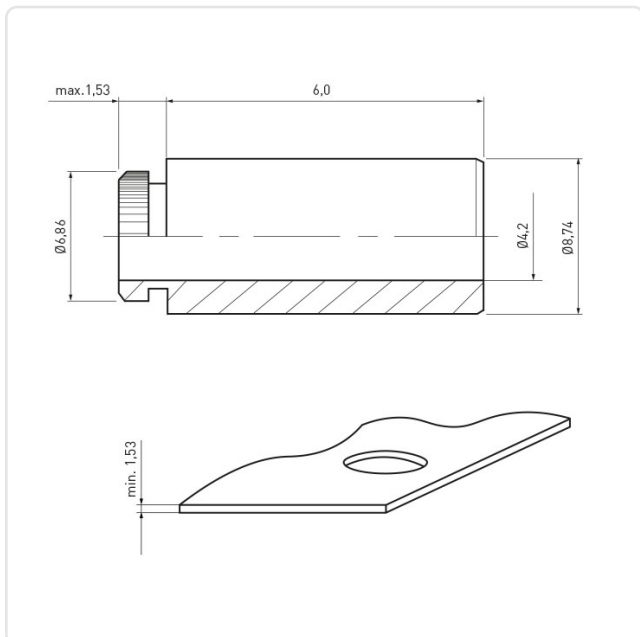

Image may be similar

Area of Application:	For Plastics
Finish:	Tin-Plated
Inner Diameter [mm]:	4.2
Length [mm]:	6
Material:	Steel
Minimum Edge Distance [mm]:	7.1
Outer Diameter [mm]:	8.7
Panel Hole \O [mm]:	6.4
Panel Thickness [mm]:	1,5
Weight:	2.35g
Conformities:	



You can find all
information on the web on
our article detail page



Would you like individual advice?

We look forward to your email to products@ettinger.de.

Subject to change and errors.