

Article datasheet

PCB Support 4.8 Self-Adhesive Polyamide 6.6 natural

Article-No.: 006.95.046

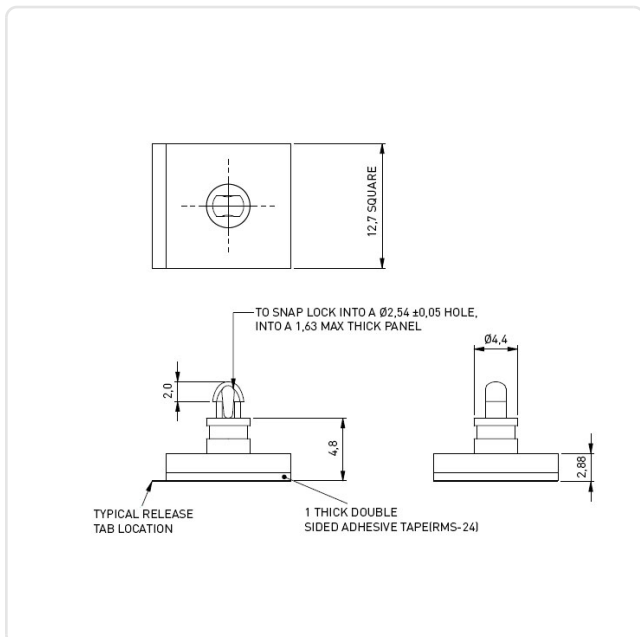

Image may be similar

Color: Natural
 Flammability Class: UL94-V2
 Length [mm]: 4.8
 Material: PA 6.6
 PCB Hole Ø [mm]: 2.5
 PCB Thickness [mm]: 1,6
 Weight: 0.47g
 Conformities:



You can find all information on the web on our article detail page



Would you like individual advice?

We look forward to your email to products@ettinger.de.

Subject to change and errors.