

Article datasheet

## Swage Standoff M3x5.0 Tin-Plated Steel

Article-No.: 004.60.325

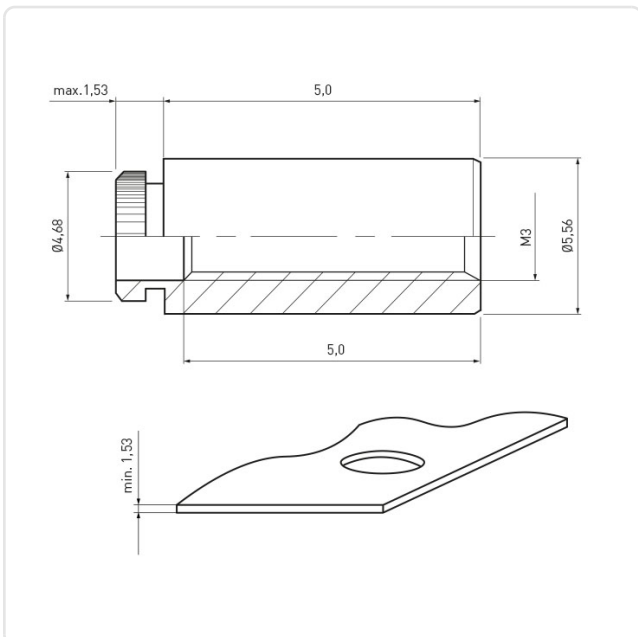

Image may be similar

Area of Application:	For Plastics
Finish:	Tin-Plated
Length [mm]:	5
Material:	Steel
Minimum Edge Distance [mm]:	4.4
Outer Diameter [mm]:	5.6
Panel Hole Ø [mm]:	4.2
Panel Thickness [mm]:	1,5
Thread Size:	M3
Weight:	0.8g
Conformities:	



You can find all  
information on the web on  
our article detail page



Would you like individual advice?

We look forward to your email to [products@ettinger.de](mailto:products@ettinger.de).

Subject to change and errors.