

Article datasheet

## Lock Nut DIN985/ISO10511 M10 Galvanized Steel

Article-No.: 002.08.110

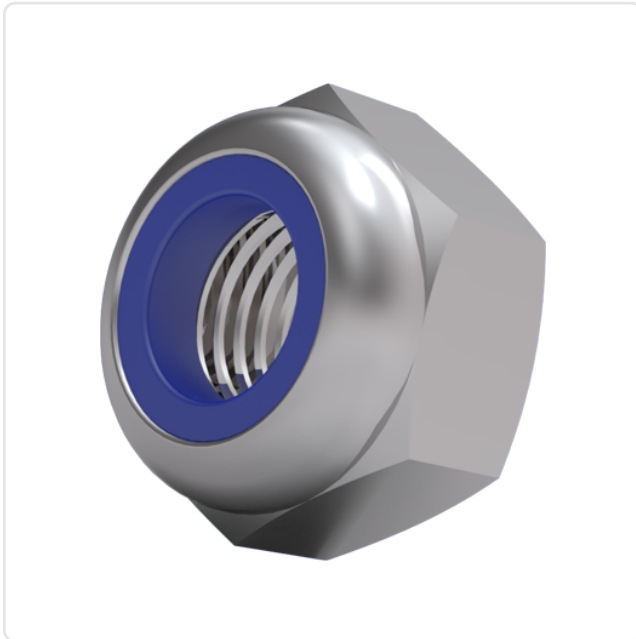
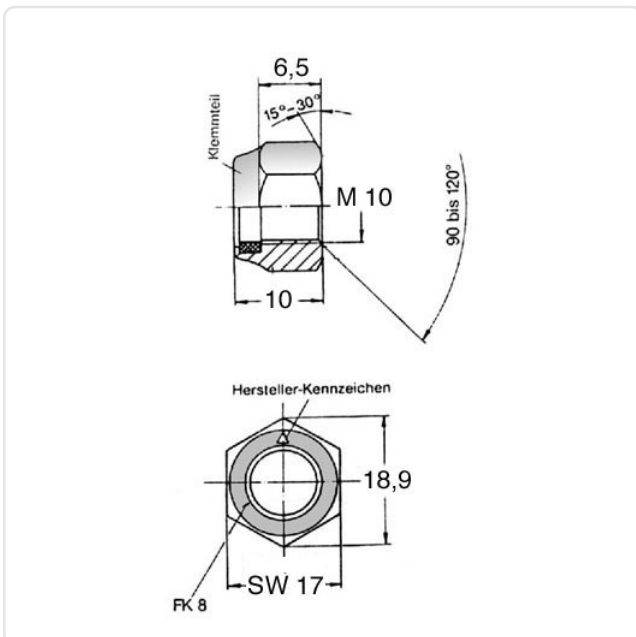

Image may be similar

AF / OD [mm]: 17  
DIN/ISO: DIN985 / ISO10511  
Finish: Galvanized, Blue, 5 µm, A2K  
Height [mm]: 10  
Material: Steel  
Material Group: Steel  
Thread Size: M10  
Weight: 10.53g  
Conformities:



You can find all information on the web on our article detail page



Would you like individual advice?

We look forward to your email to [products@ettinger.de](mailto:products@ettinger.de).

Subject to change and errors.