

Article datasheet

Round Spacer Ø3.7/6.4 x 6.0 PVC gray Self-Retaining

Article-No.: 007.43.006

Manufacturer: BIVAR

Manufacturer article-no.: SRS-4-6MM

BIVAR

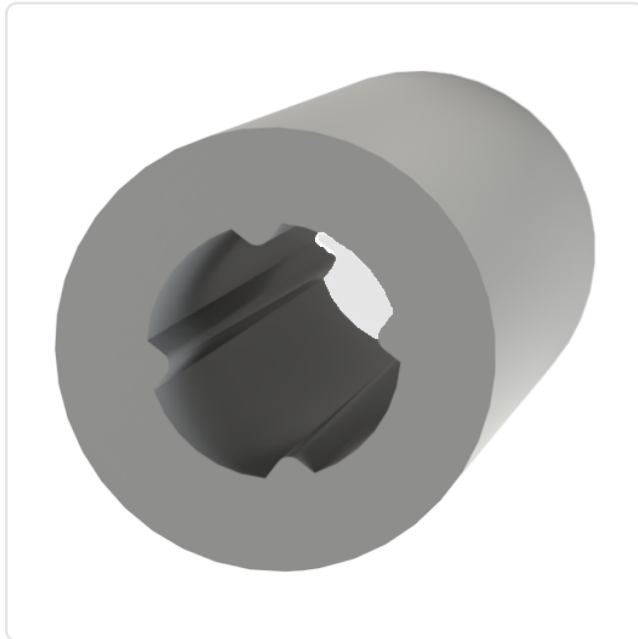

Image may be similar

Color: Gray
Flammability Class: UL94-V0
For Thread Size: M3
Inner Diameter [mm]: 3.7
Length [mm]: 6
Material: PVC - Polyvinyl Chloride
Material Group: Kunststoff
Outer Diameter [mm]: 6.4
Weight: 0.19g
Conformities:



You can find all
information on the web on
our article detail page

Would you like individual advice?

We look forward to your email to products@ettinger.de.

Subject to change and errors.

