

Article datasheet

Screw for T-Slot DIN787 M12x40/25 Plain Steel 8.8

Article-No.: 001.42.121

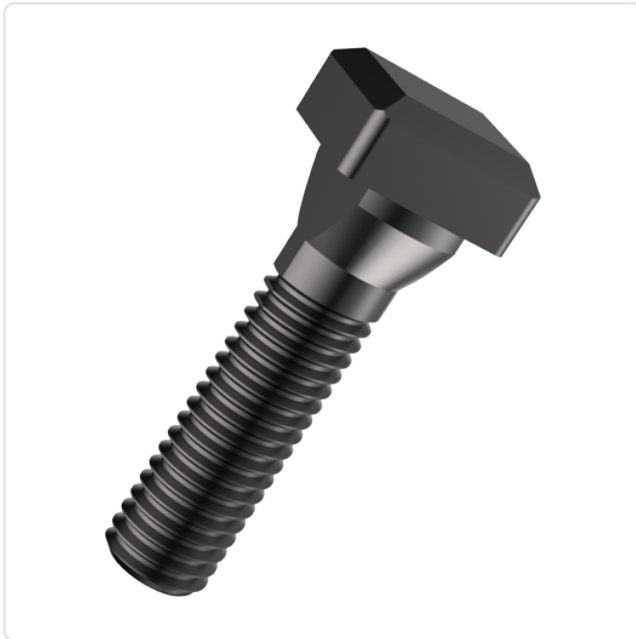
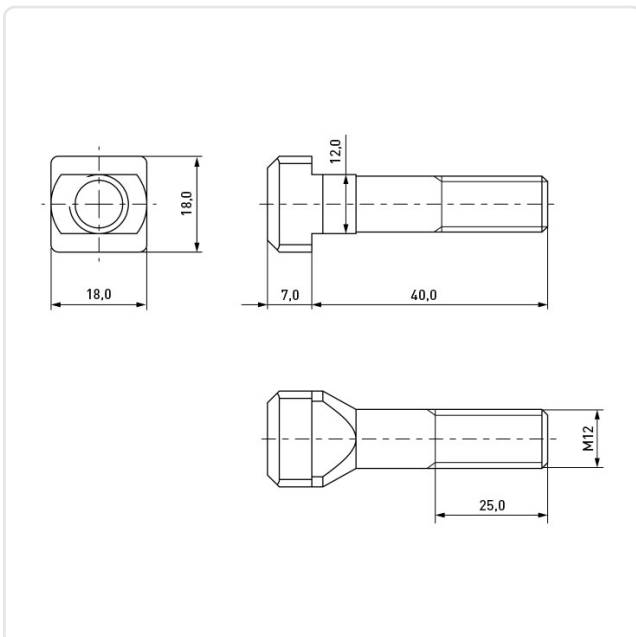

Image may be similar

DIN/ISO:	DIN787
Finish:	Plain
Head Height [mm]:	7
Head Shape:	Hammer Head
Length [mm]:	40
Material:	Steel 8.8
Slot Width [mm]:	12
Thread Length [mm]:	25
Thread Size:	M12
Conformities:	



You can find all information on the web on our article detail page



Would you like individual advice?

We look forward to your email to products@ettinger.de.

Subject to change and errors.