

Article datasheet

Mounting Button Panel 8.7-10.3mm Polyamid 6.6,natural UL94-V2 E70062

Article-No.: 072.88.086

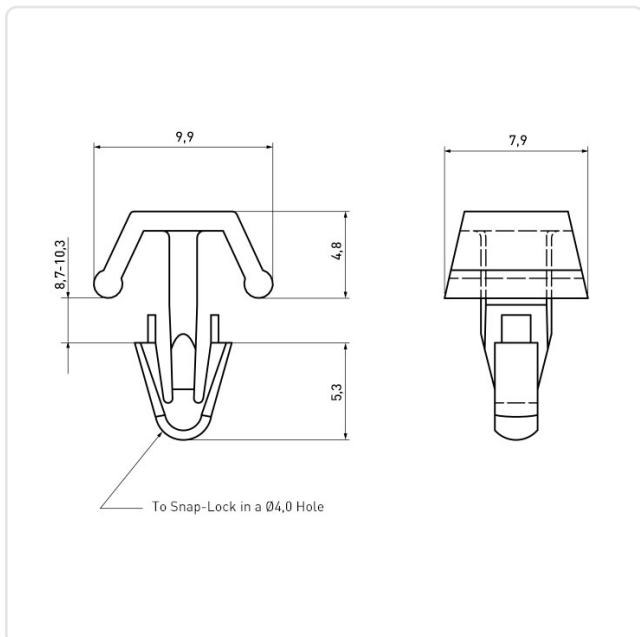

Image may be similar

Color: Natural
Flammability Class: UL94-V2
Head Diameter [mm]: 9.9
Material: PA 6.6
Mounting Hole [mm]: 4
Panel Thickness Range [mm]: 8.7-10.3mm
Weight: 0.25g
Conformities:



You can find all
information on the web on
our article detail page



Would you like individual advice?

We look forward to your email to products@ettinger.de.

Subject to change and errors.