

Article datasheet

## Conical Spring Washer $\varnothing 4.3/7.2 \times 0.4$ A2 Plain Stainless Steel

Article-No.: 003.24.942

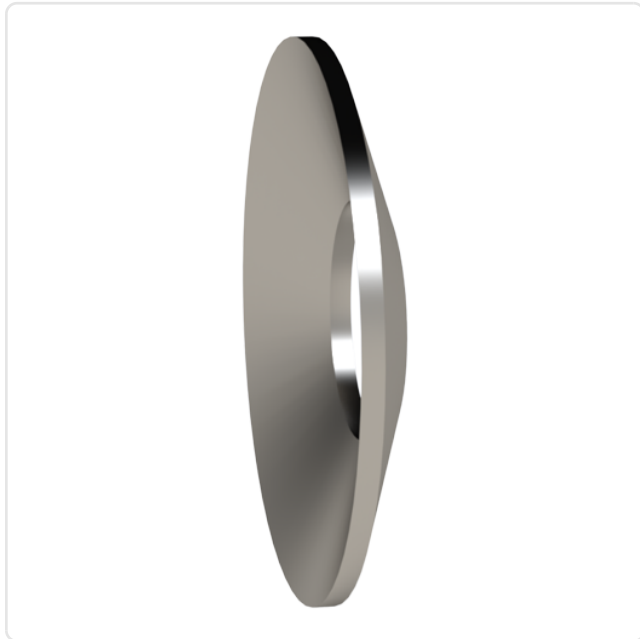
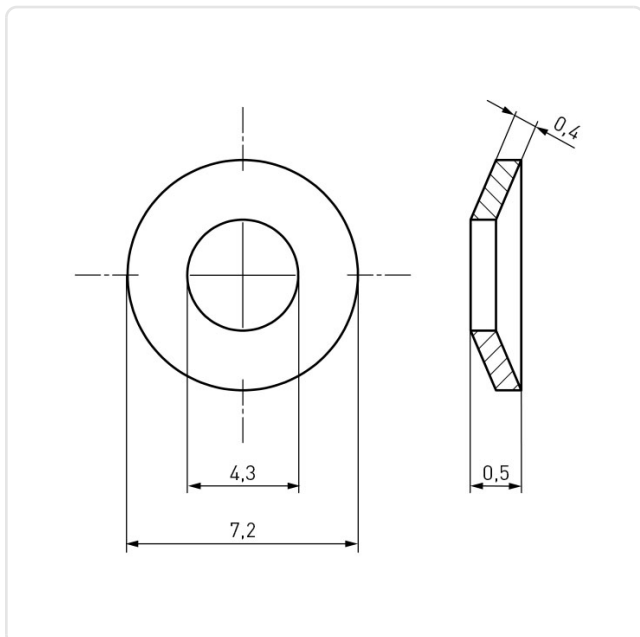

Image may be similar

Finish: Plain  
For Thread Size: M4  
Height [mm]: 0.4  
Inner Diameter [mm]: 4.3  
Material: Stainless Steel AISI 304 / A2  
Material Group: Stainless Steel  
Outer Diameter [mm]: 7.2  
Weight: 0.07g  
Conformities:



You can find all information on the web on our article detail page



Would you like individual advice?

We look forward to your email to [products@ettinger.de](mailto:products@ettinger.de).

Subject to change and errors.