

Article datasheet

## Locking and Sealing Washer $\text{\O}3.2/8.0 \times 2.5$ Polyamide 6 natural

Article-No.: 003.07.236

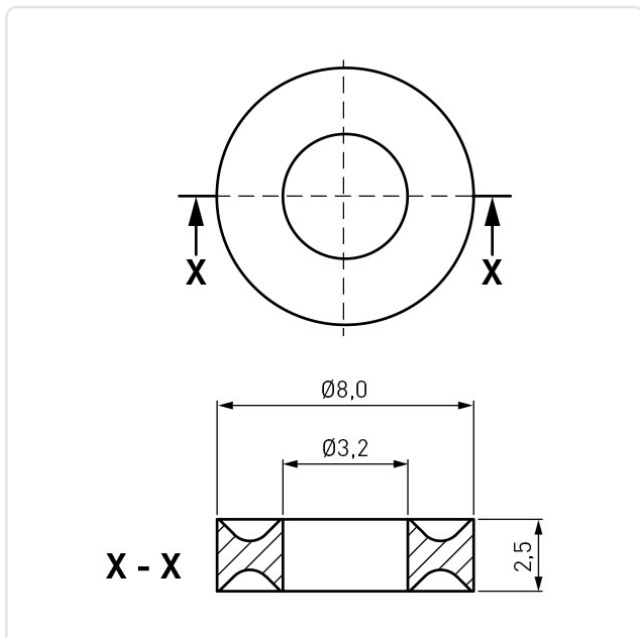

Image may be similar

For Thread Size: M3  
Height [mm]: 2.5  
Inner Diameter [mm]: 3.2  
Material: PA 6.0  
Material Group: Plastic  
Outer Diameter [mm]: 8  
Weight: 0.08g  
Conformities:



You can find all  
information on the web on  
our article detail page



Would you like individual advice?

We look forward to your email to [products@ettinger.de](mailto:products@ettinger.de).

Subject to change and errors.