

Article datasheet

Solder Terminal Pin $\varnothing 1.3 \times 11.0$ mm Brass tinned - round press-in shaft

Article-No.: 013.14.225

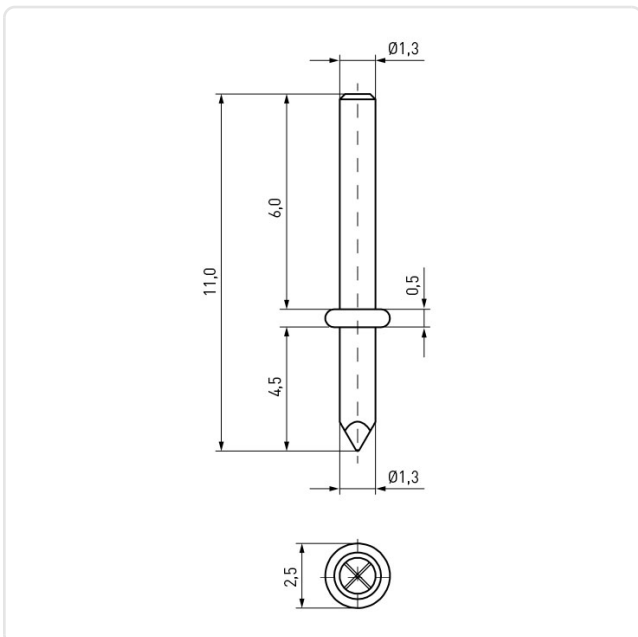

Image may be similar

Diameter [mm]: 1.3
Finish: Tin-Plated
Length [mm]: 11
Material: Brass
Model: round
PCB Hole \varnothing [mm]: 1.3
Weight: 0.14g
Conformities:



You can find all
information on the web on
our article detail page



Would you like individual advice?

We look forward to your email to products@ettinger.de.

Subject to change and errors.