

Article datasheet

## PCB Support 15.9 | $\varnothing$ 4.8 Polyamide 6.6 natural

Article-No.: 006.06.546

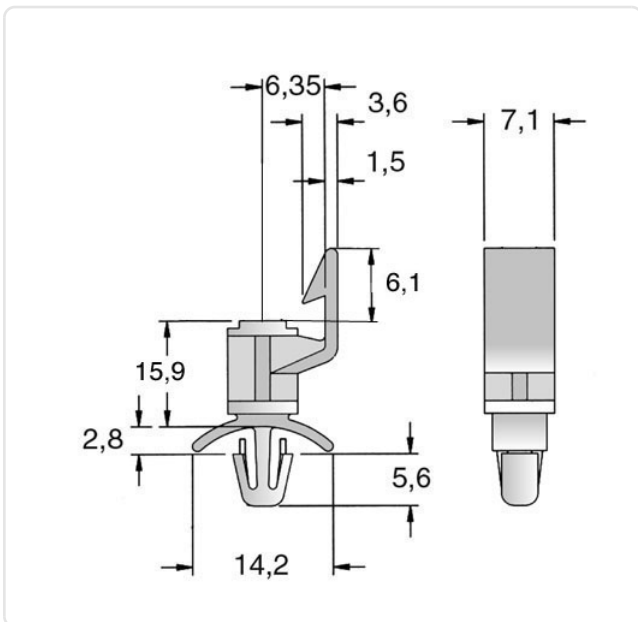

Image may be similar

Color: Natural  
Flammability Class: UL94-V2  
Length [mm]: 15.9  
Material: PA 6.6  
Panel Hole  $\varnothing$  [mm]: 4.8  
Panel Thickness [mm]: 0,8-2,0  
Weight: 0.94g  
Conformities:



You can find all information on the web on our article detail page



Would you like individual advice?

We look forward to your email to [products@ettinger.de](mailto:products@ettinger.de).

Subject to change and errors.