

Article datasheet

Retaining Ring $\text{\O}2.0/9.7 \times 1.3$ Burnished Spring Steel

Article-No.: 003.15.421

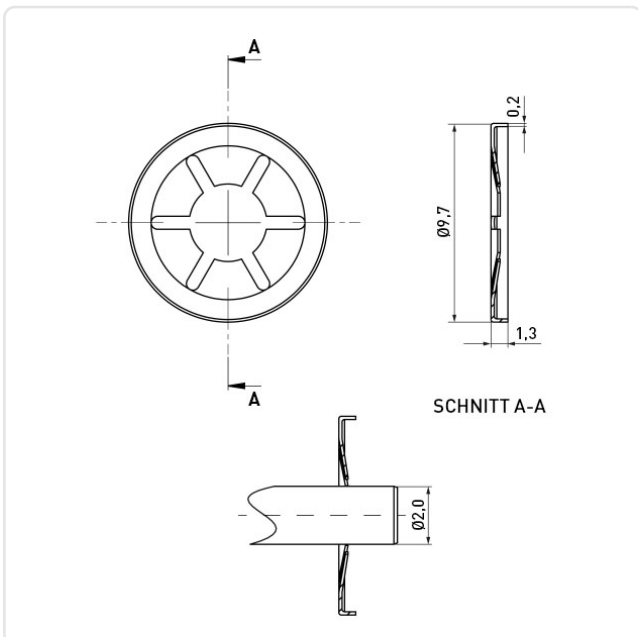

Image may be similar

Finish: Burnished
Height [mm]: 1.3
Material: Spring Steel
Material Group: Steel
Outer Diameter [mm]: 9.7
Weight: 0.13g
Conformities:



You can find all
information on the web on
our article detail page



Would you like individual advice?

We look forward to your email to products@ettinger.de.

Subject to change and errors.