

Article datasheet

Long Nut M12 DIN6334 A4 Stainless Steel AF 19x36 / M12

Article-No.: 002.20.129

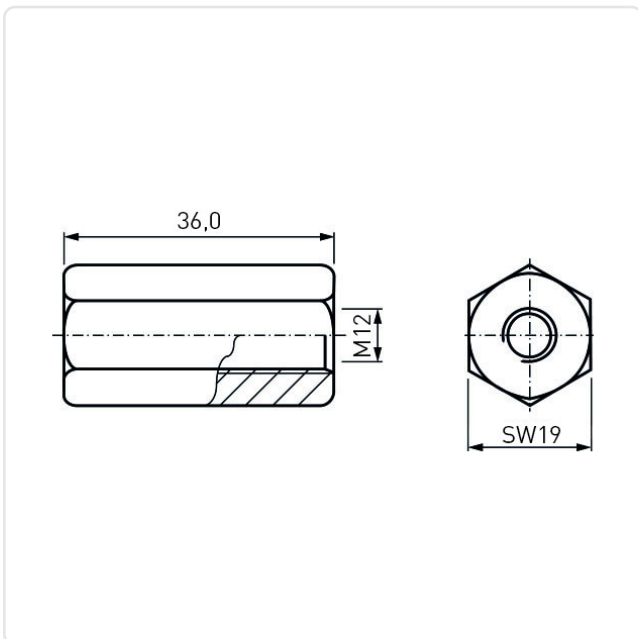

Image may be similar

DIN/ISO: DIN6334
Finish: Plain
Length [mm]: 36
Material: Stainless Steel AISI 316 / A4
Material Group: Stainless Steel
Profile: Hexagonal
Thread Size: M12
Conformities:



You can find all
information on the web on
our article detail page



Would you like individual advice?

We look forward to your email to products@ettinger.de.

Subject to change and errors.