

Article datasheet

## Nut for T-Slot DIN508 M6x10 Plain Steel 10

Article-No.: 002.04.062

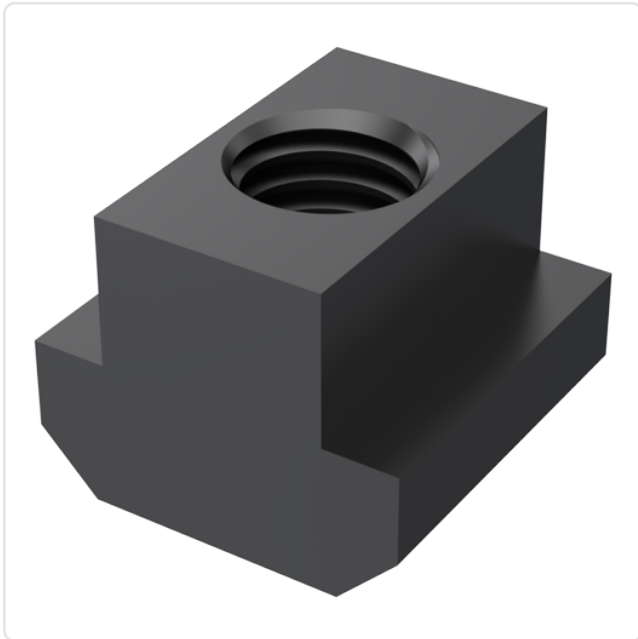

Image may be similar

DIN/ISO:	DIN508
Finish:	Plain
Head Height [mm]:	6
Height [mm]:	10
Length [mm]:	13
Material:	Steel - Grade 10
Slot Width [mm]:	10
Thread Size:	M6
Conformities:	



You can find all information on the web on our article detail page

Would you like individual advice?

We look forward to your email to [products@ettinger.de](mailto:products@ettinger.de).

Subject to change and errors.

