

Article datasheet

## PCB Support 7.9 Self-Adhesive Polyamide 6.6 natural

Article-No.: 006.95.076

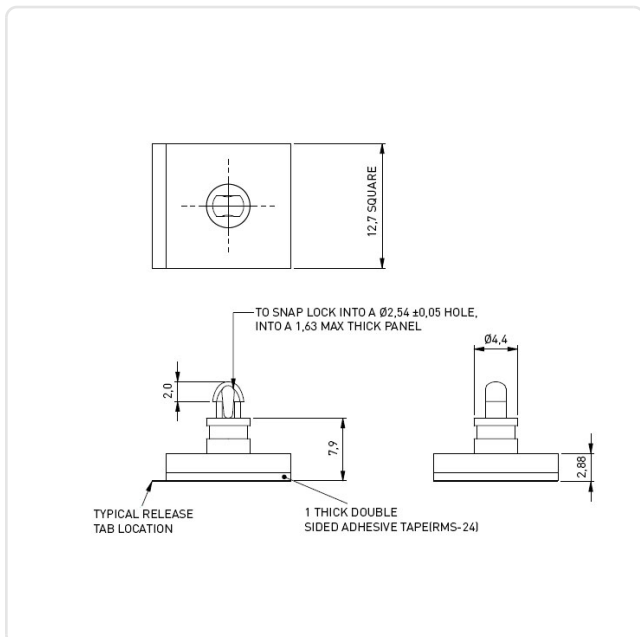

Image may be similar

Color: Natural  
 Flammability Class: UL94-V2  
 Length [mm]: 7.9  
 Material: PA 6.6  
 PCB Hole Ø [mm]: 2.5  
 PCB Thickness [mm]: 1,6  
 Weight: 0.5g  
 Conformities:



You can find all information on the web on our article detail page



Would you like individual advice?

We look forward to your email to [products@ettinger.de](mailto:products@ettinger.de).

Subject to change and errors.