

Article datasheet

Flat Head Screw ISO7045 M2.5x12 Nickel-Plated ST 4.8 C/R Pan Head

Article-No.: 001.17.253



Image may be similar

Actuator Size:	Phillips PH1
DIN/ISO:	DIN7985 / ISO7045
Drive Type:	Cross Recess / Phillips-H
Finish:	Nickel-Plated, 3 µm, E1E
Head Diameter [mm]:	5
Head Height [mm]:	2
Head Shape:	Pan Head
Length [mm]:	12
Material:	Steel 4.8
Material Group:	Steel
Thread Size:	M2.5
Weight:	0.56g
Conformities:	

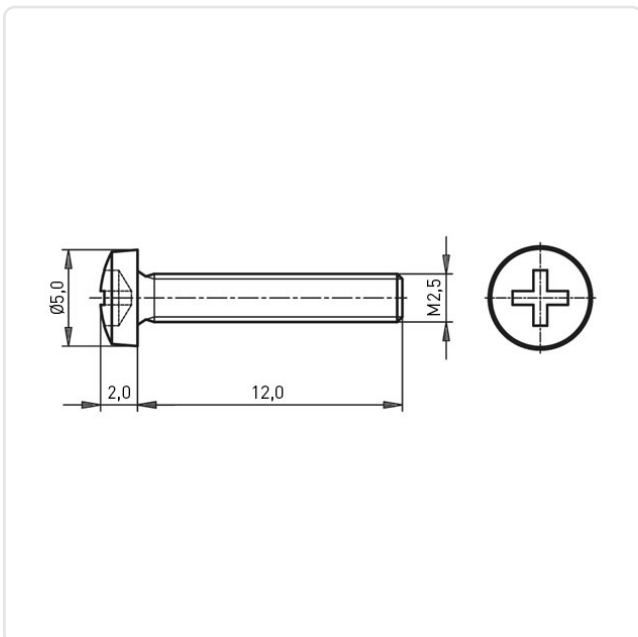

You can find all
information on the web on
our article detail page

Would you like individual advice?

We look forward to your email to products@ettinger.de.

Subject to change and errors.