

Article datasheet

PCB Support 9.1 | \varnothing 4.8 Polyamide 6.6 natural

Article-No.: 006.70.826

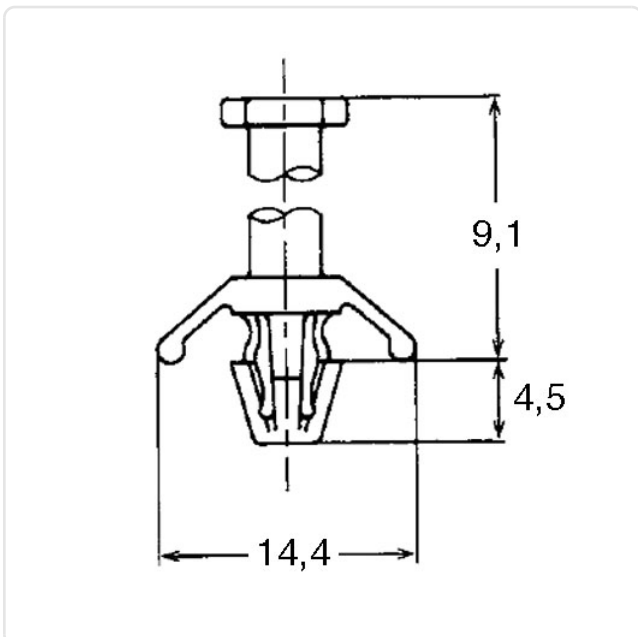

Image may be similar

Color:	Natural
Flammability Class:	UL94-V2
Length [mm]:	9.1
Material:	PA 6.6
Material Group:	Plastic
Panel Hole \varnothing [mm]:	4.8
Panel Thickness [mm]:	0,5-2,3
Weight:	0.4g
Conformities:	



You can find all information on the web on our article detail page



Would you like individual advice?

We look forward to your email to products@ettinger.de.

Subject to change and errors.