

Article datasheet

## Standoff Galvanized Steel Self-Tapping AF5.5x15 F=M3x10 M=ST2.9x6 w/ UC

Article-No.: 005.20.315



Image may be similar

AF / OD [mm]:	5.5
Female Thread Length [mm]:	10
Female Thread Size:	M3
Finish:	Galvanized, Blue, 5 µm, A2K
Length [mm]:	15
Male Thread Length [mm]:	6
Male Thread Size:	ST2.9 Self-Tapping
Material:	Steel AISI 12L13 / 11SMnPb30
Material Group:	Stahl
Profile:	Hexagonal
Undercut:	Yes
Weight:	2.58g
Conformities:	

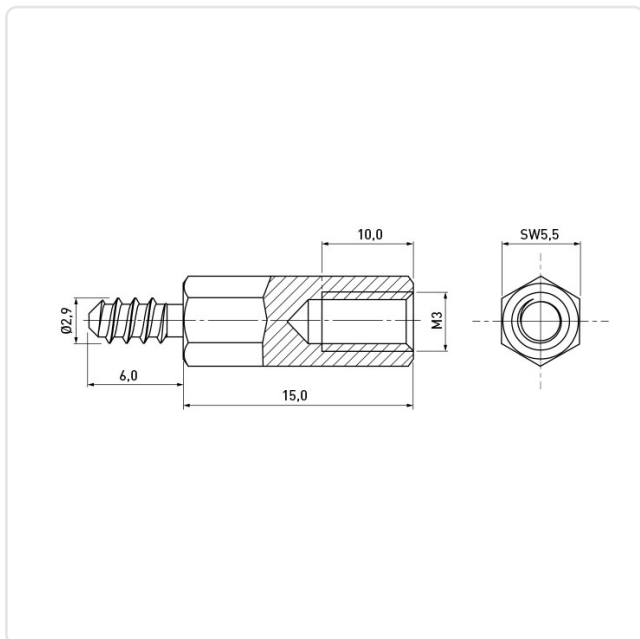

You can find all  
information on the web on  
our article detail page

Would you like individual advice?

We look forward to your email to [products@ettinger.de](mailto:products@ettinger.de).

Subject to change and errors.