

Article datasheet

Retaining Ring Ø7.0/13.0 x 3.0 POM red

Article-No.: 003.15.108

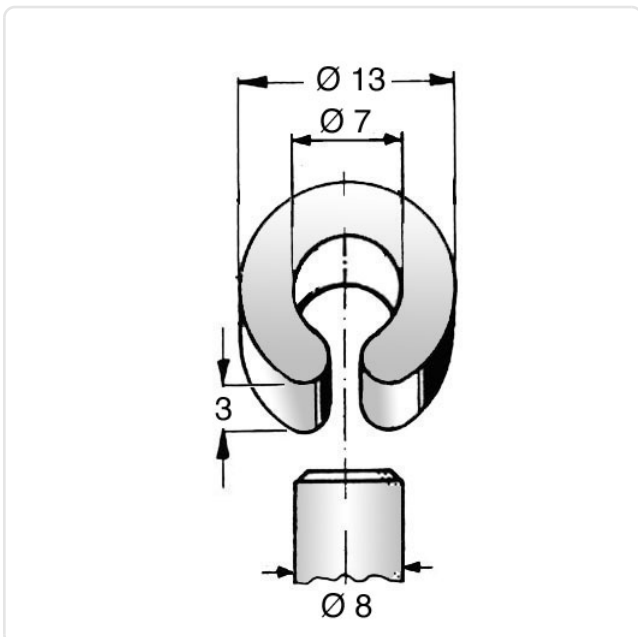

Image may be similar

Color: Red
Height [mm]: 3
Inner Diameter [mm]: 7
Material: POM - Polyoxymethylene
Material Group: Kunststoff
Outer Diameter [mm]: 13
Weight: 0.33g
Conformities:



You can find all
information on the web on
our article detail page



Would you like individual advice?

We look forward to your email to products@ettinger.de.

Subject to change and errors.