

Article datasheet

Thread Insert M3 | 4.1 Plain Brass

Article-No.: 002.21.432



Image may be similar

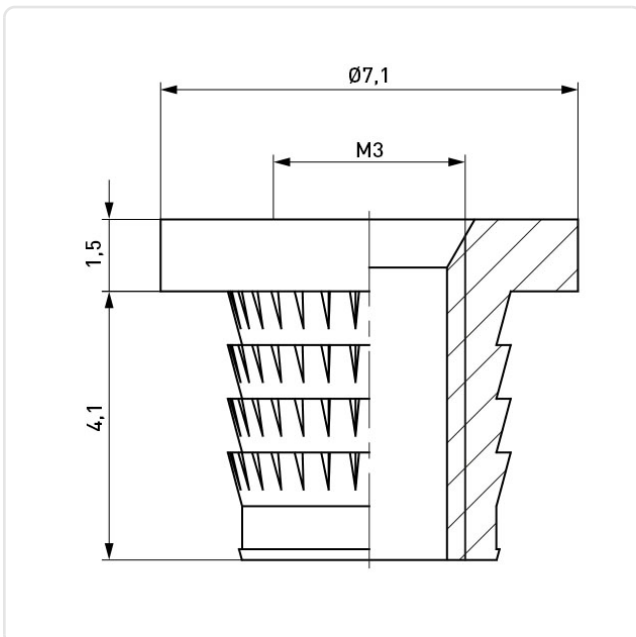

Finish:	Plain
Head Diameter [mm]:	7.1
Length [mm]:	4.1
Material:	Brass
Material Group:	Brass
Minimum Edge Distance [mm]:	1.7
Panel Hole \varnothing [mm]:	4
Thread Size:	M3
Weight:	0.6g
Conformities:	



You can find all information on the web on our article detail page

Would you like individual advice?

We look forward to your email to products@ettinger.de.

Subject to change and errors.