

Article datasheet

## Blind Rivet Ø4.0x8.5 Aluminum Shell / Steel Mandrel

Article-No.: 001.08.438



Image may be similar

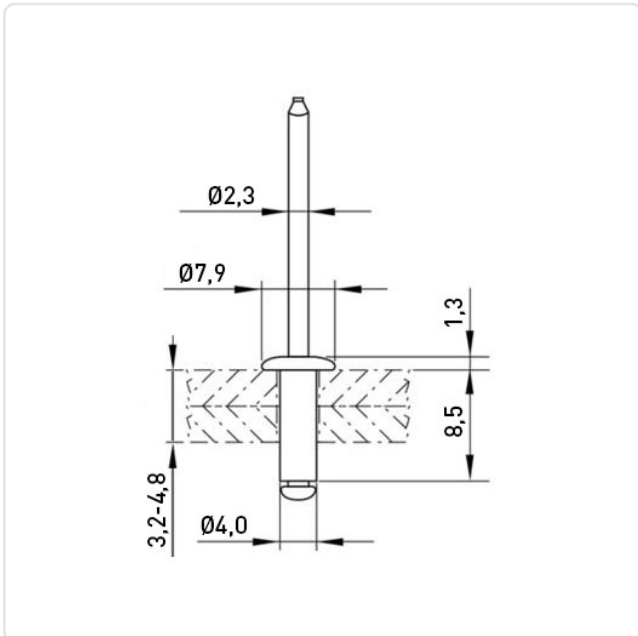

Finish:	Plain
Head Diameter [mm]:	7.9
Length [mm]:	8.5
Mandrel Diameter [mm]:	2.3
Material:	Aluminum Shell / Steel Mandrel
Mounting Hole [mm]:	4.1
Panel Thickness [mm]:	3,2-4,8
Rivet Diameter [mm]:	4
Weight:	1.76g
Conformities:	



You can find all information on the web on our article detail page

Would you like individual advice?

We look forward to your email to [products@ettinger.de](mailto:products@ettinger.de).

Subject to change and errors.