

Article datasheet

Standoff Polyamide 6.6 Black M/F AF10x40 F=M5x10 M=M5x8 w/o Undercut

Article-No.: 005.45.540



Image may be similar

AF / OD [mm]:	10
Color:	Black
Female Thread Length [mm]:	10
Female Thread Size:	M5
Flammability Class:	UL94-HB
Length [mm]:	40
Male Thread Length [mm]:	8
Male Thread Size:	M5
Material:	PA 6.6
Material Group:	Plastic
Profile:	Hexagonal
Undercut:	No
Weight:	3.26g
Conformities:	

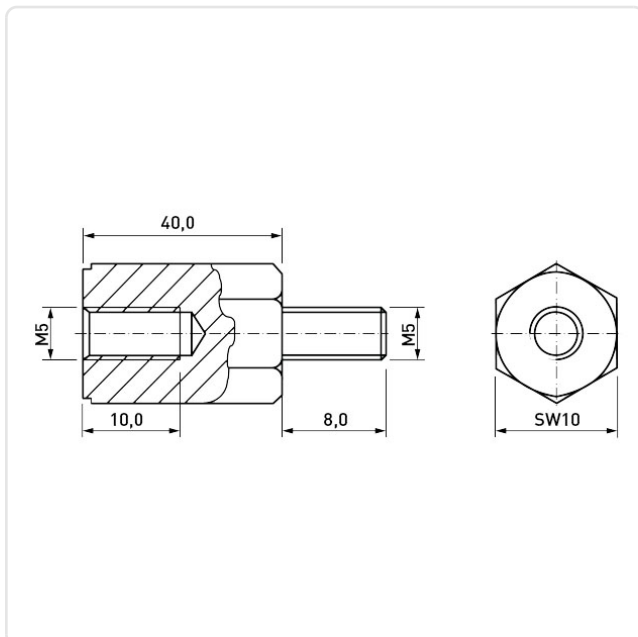

You can find all
information on the web on
our article detail page

Would you like individual advice?

We look forward to your email to products@ettinger.de.

Subject to change and errors.