

Article datasheet

Arrow disk for round knob \varnothing 31 mm

Article-No.: 041.31.802

Manufacturer: OKW Gehäusesysteme

Manufacturer article-no.: A42.31.002

OKW
GEHÄUSE
SYSTEME

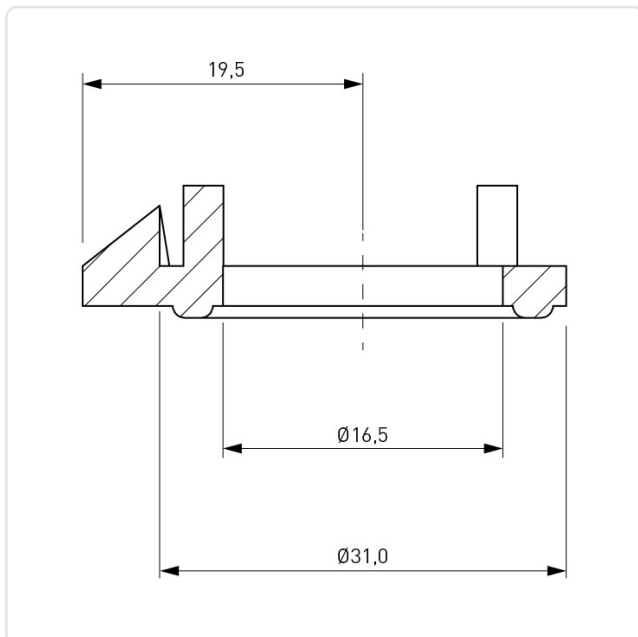

Image may be similar

Color: Red
Marking: Arrow
Material: ABS - Acrylonitrile Butadiene Styrene
Material Group: Plastic
Model: Arrow Disk for Combination Knob
Outer Diameter [mm]: 31
Weight: 0.7g
Conformities:



You can find all
information on the web on
our article detail page



Would you like individual advice?

We look forward to your email to products@ettinger.de.

Subject to change and errors.