

Article datasheet

PCB Support 22.2 | \varnothing 4.0 Polyamide 6.6 natural

Article-No.: 006.07.166

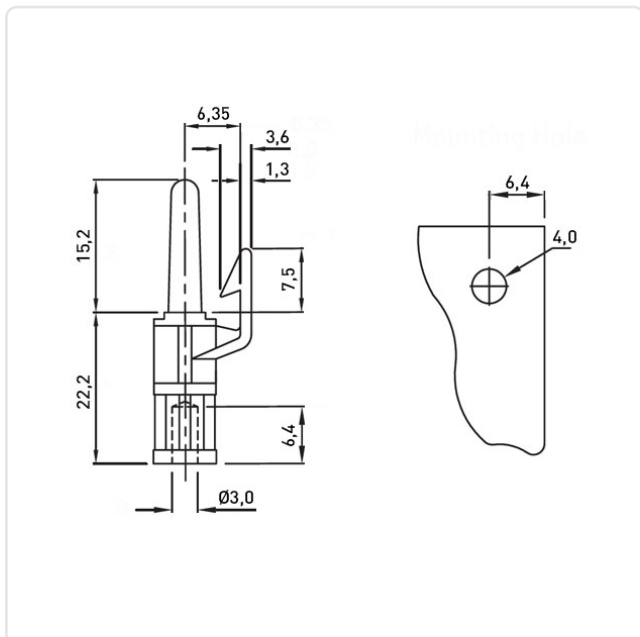

Image may be similar

Color: Natural
Flammability Class: UL94-V2
Length [mm]: 22.2
Material: PA 6.6
PCB Hole \varnothing [mm]: 4
PCB Thickness [mm]: 1,6
Panel Hole \varnothing [mm]: 3
Weight: 0.82g
Conformities:



You can find all information on the web on our article detail page



Would you like individual advice?

We look forward to your email to products@ettinger.de.

Subject to change and errors.