

Article datasheet

Ball Knob, bright polished / similar DIN319-C

Article-No.: 002.34.340

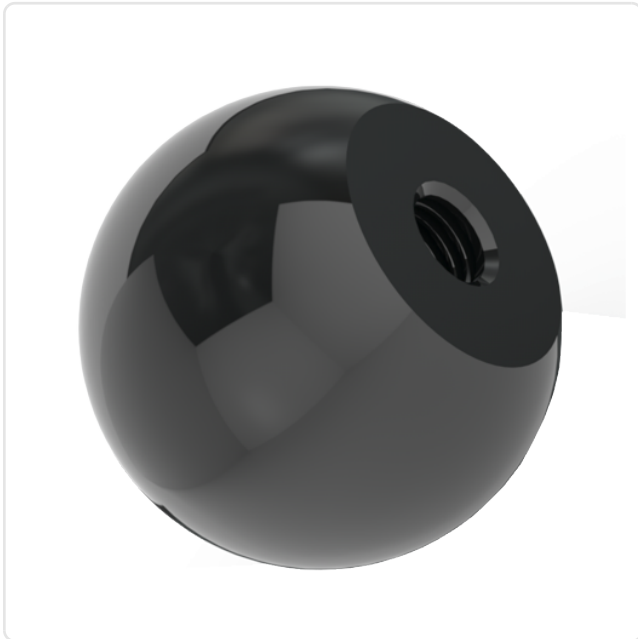
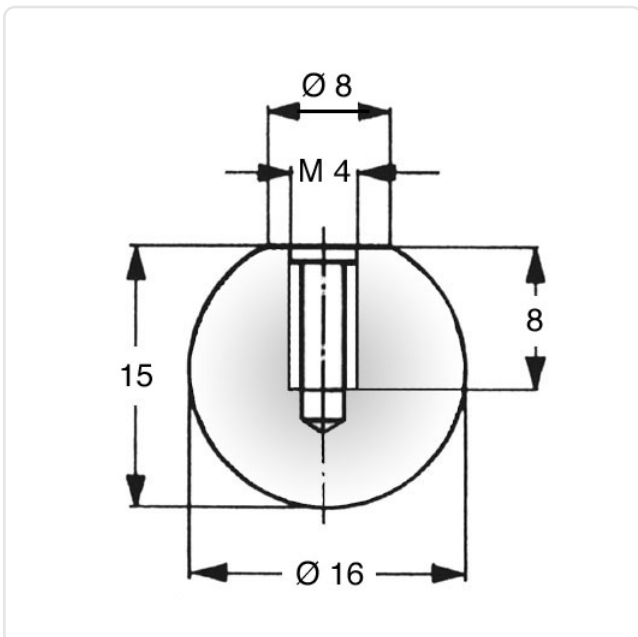

Image may be similar

Color: Black
Diameter [mm]: 16
Material: PA 6.0
Material Group: Zink-Druckguss
Thread Size: M4
Weight: 2.94g
Conformities:



You can find all
information on the web on
our article detail page



Would you like individual advice?

We look forward to your email to products@ettinger.de.

Subject to change and errors.