

Article datasheet

Thread Forming Screw DIN7500C M2.5x6 Galv. Steel Case Hardened Torx Pan Head

Article-No.: 001.31.221

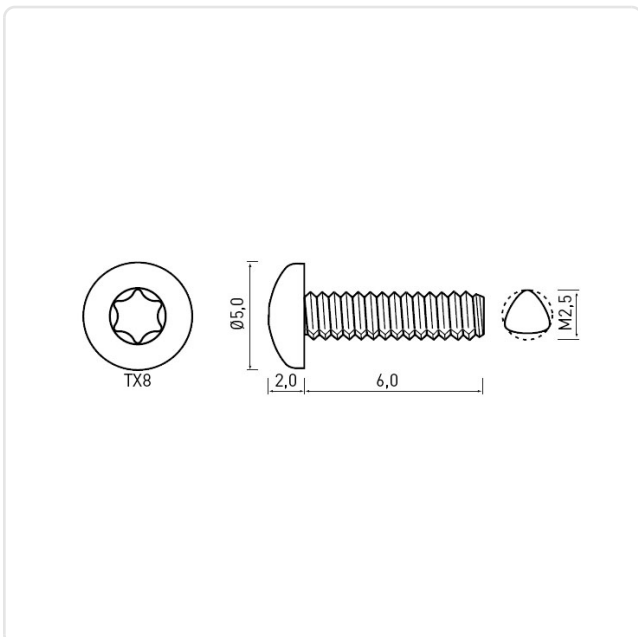

Image may be similar

Actuator Size:	Torx T8
DIN/ISO:	DIN7500-C
Drive Type:	TORX
Finish:	Galvanized, Blue, 5 µm, A2K
Head Diameter [mm]:	5
Head Height [mm]:	2.2
Head Shape:	Pan Head
Length [mm]:	6
Material:	Case-Hardened Steel
Material Group:	Steel
Thread Size:	M2.5
Thread Type:	Metric
Weight:	0.38g
Conformities:	



You can find all information on the web on our article detail page



Would you like individual advice?

We look forward to your email to products@ettinger.de.

Subject to change and errors.