

Article datasheet

Nut for T-Slot DIN508 M5x6 Plain Steel 10

Article-No.: 002.04.051

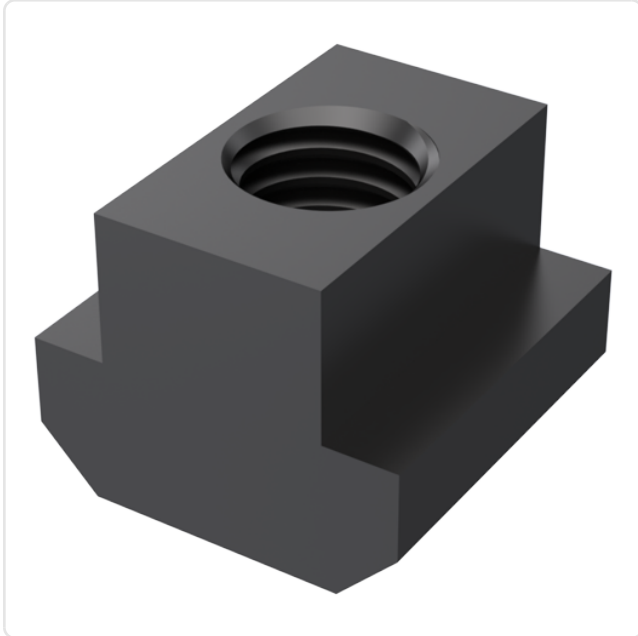

Image may be similar

DIN/ISO: DIN508
Finish: Plain
Head Height [mm]: 4
Height [mm]: 8
Length [mm]: 10
Material: Steel - Grade 10
Slot Width [mm]: 6
Thread Size: M5
Conformities:



You can find all information on the web on our article detail page

Would you like individual advice?

We look forward to your email to products@ettinger.de.

Subject to change and errors.

