

Article datasheet

Flat Head Screw ISO7045 M3x8 Galvanized Steel 4.8 C/R Pan Head

Article-No.: 001.17.331

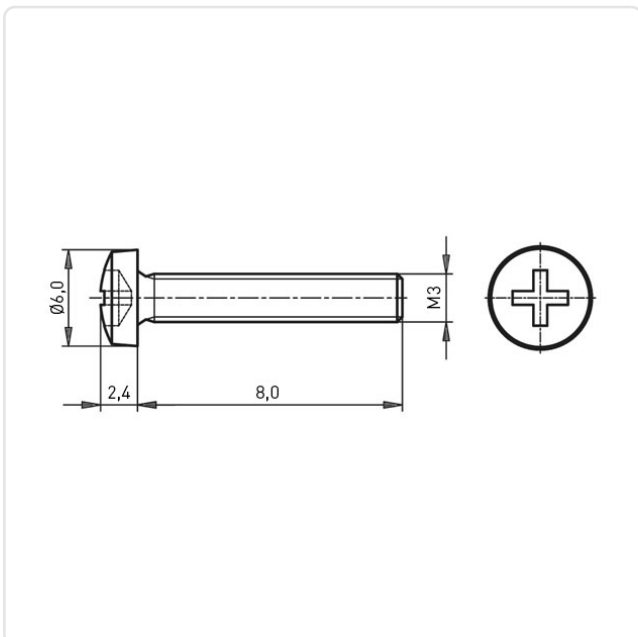

Image may be similar

Actuator Size:	Phillips PH1
DIN/ISO:	DIN7985 / ISO7045
Drive Type:	Cross Recess / Phillips-H
Finish:	Galvanized, Blue, 5 µm, A2K
Head Diameter [mm]:	6
Head Height [mm]:	2.4
Head Shape:	Pan Head
Length [mm]:	8
Material:	Steel 4.8, lead-free
Material Group:	Stahl
Thread Size:	M3
Weight:	0.7g
Conformities:	



You can find all
information on the web on
our article detail page



Would you like individual advice?

We look forward to your email to products@ettinger.de.

Subject to change and errors.