

Article datasheet

## Lock Nut M5 Polyamide 6.6 natural

Article-No.: 002.05.356

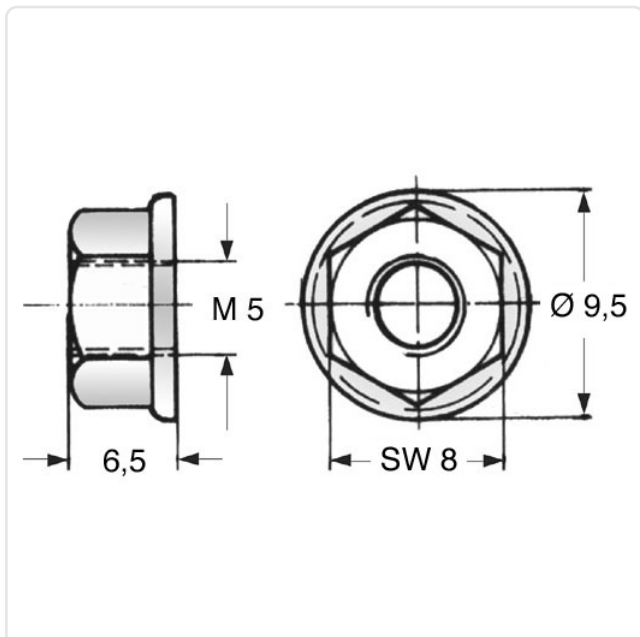

Image may be similar

AF / OD [mm]: 8  
Height [mm]: 6.5  
Material: PA 6.6  
Material Group: Plastic  
Thread Size: M5  
Weight: 0.3g  
Conformities:



You can find all  
information on the web on  
our article detail page



Would you like individual advice?

We look forward to your email to [products@ettinger.de](mailto:products@ettinger.de).

Subject to change and errors.