

Article datasheet

## Weld Nut DIN929 M4 A2 Plain Stainless Steel Hexagon

Article-No.: 002.31.048

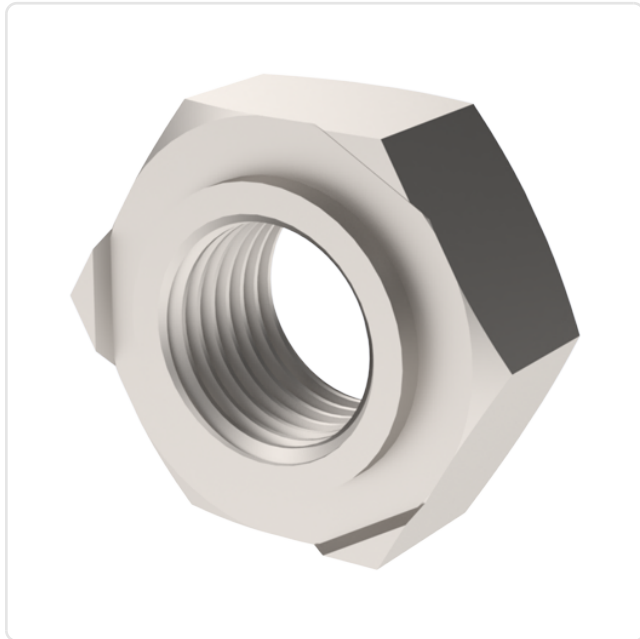
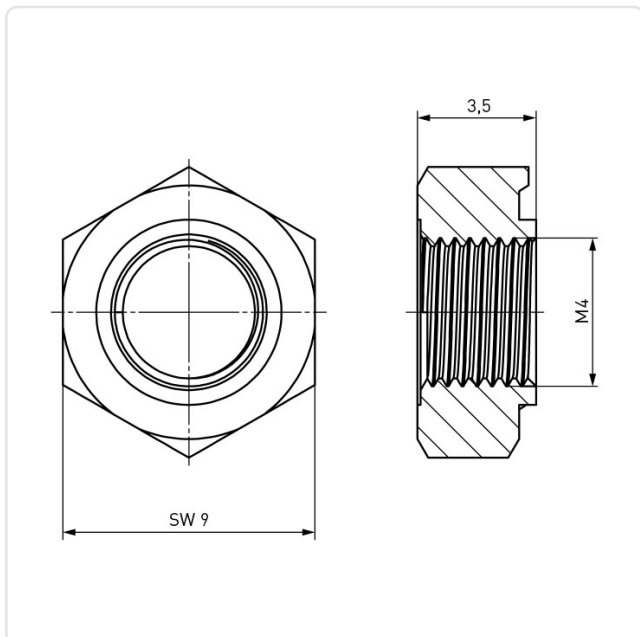

Image may be similar

AF / OD [mm]: 9  
DIN/ISO: DIN929  
Finish: Plain  
Height [mm]: 3.5  
Material: Stainless Steel AISI 304 / A2  
Thread Size: M4  
Conformities:



You can find all  
information on the web on  
our article detail page



Would you like individual advice?

We look forward to your email to [products@ettinger.de](mailto:products@ettinger.de).

Subject to change and errors.