

Article datasheet

Pan Head Screw ISO1580 M3x6 A4 STEEL Slotted Self-Sealing SEELSKREW®

Article-No.: 001.59.329

Manufacturer: APM Hexseal

Manufacturer article-no.: SM3X6 SEELSKREW





Image may be similar

DIN/ISO:	DIN85 / ISO1580
Drive Type:	Slotted
Finish:	Passivated, Clear
Head Diameter [mm]:	6
Head Height [mm]:	1.8
Head Shape:	Flat Head
Length [mm]:	6
Material:	Stainless Steel AISI 316 / A4
Material Group:	Stainless Steel
O-Ring Material:	Silicone
Temperature Range [°C]:	-106°C to +260°C
Thread Size:	M3
Weight:	0.5g
Conformities:	

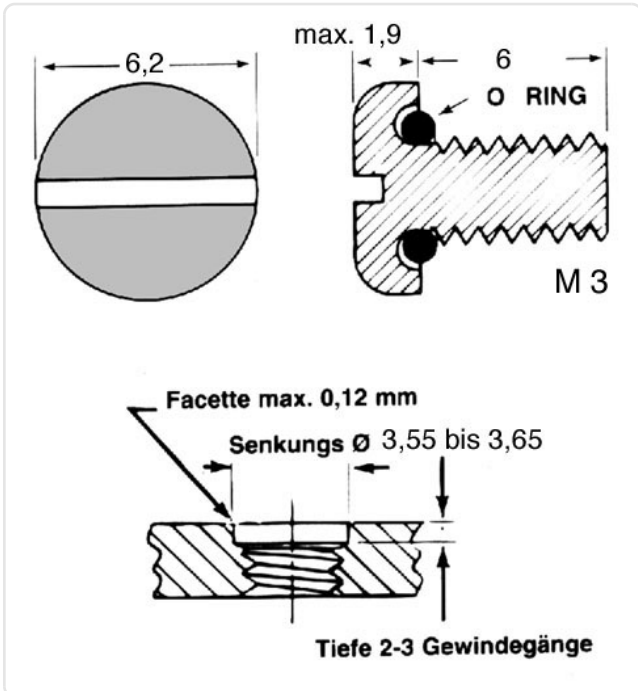

You can find all information on the web on our article detail page

Would you like individual advice?

We look forward to your email to products@ettinger.de.

Subject to change and errors.