

Article datasheet

Blade Terminal 4x 6.3x0.8 | 90° Plain Stainless Steel 1.4301

Article-No.: 019.68.149

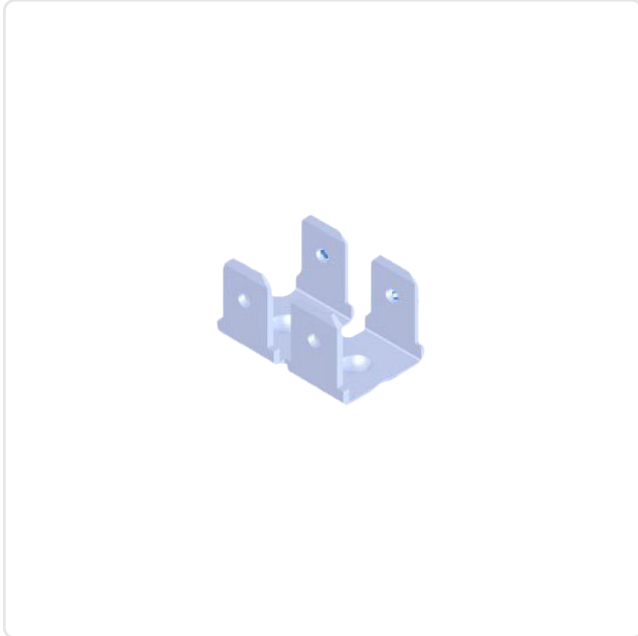
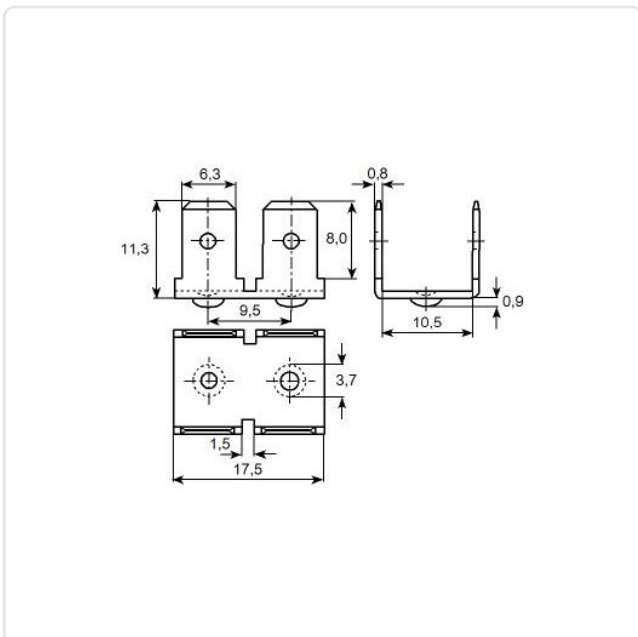

Image may be similar

Bending Angle [°]:	90
Finish:	Plain
Material:	Stainless Steel AISI 304 / X5CrNi18-10
Plug-In Length [mm]:	8
Size [mm]:	6.3x0.8
Tabs:	4
Weight:	5.08g
Conformities:	



You can find all
information on the web on
our article detail page



Would you like individual advice?

We look forward to your email to products@ettinger.de.

Subject to change and errors.