

Article datasheet

Hexagonal Screw DIN933/ISO4017 M4x6 A2 Plain Stainless Steel Hexagon

Article-No.: 001.13.422



Image may be similar

Actuator Size:	Hexagon Hex7
DIN/ISO:	DIN933 / ISO4017
Drive Type:	Hexagon
Finish:	Plain
Head Diameter [mm]:	7
Head Height [mm]:	2.8
Head Shape:	Hexagon Head
Length [mm]:	6
Material:	Stainless Steel AISI 304 / A2
Material Group:	Stainless Steel
Thread Size:	M4
Weight:	1.3g
Conformities:	

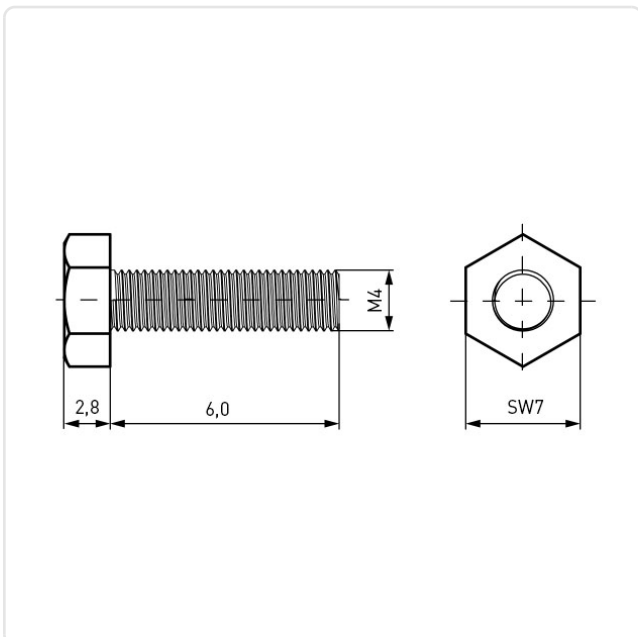

You can find all
information on the web on
our article detail page

Would you like individual advice?

We look forward to your email to products@ettinger.de.

Subject to change and errors.