

Article datasheet

Spring-Type Straight Pin ISO13337 Ø5x40 Spring Steel

Article-No.: 084.00.0540

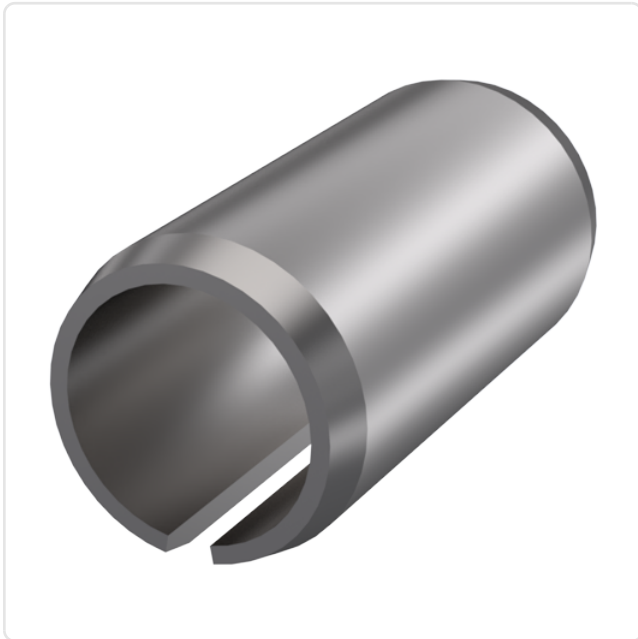

Image may be similar

DIN/ISO: ISO13337

Diameter [mm]: 5

Length [mm]: 40

Material: Spring Steel

Conformities:



You can find all
information on the web on
our article detail page

Would you like individual advice?

We look forward to your email to products@ettinger.de.

Subject to change and errors.

