

Article datasheet

PCB Support 12.7 | \varnothing 4.8 Polyamide 6.6 natural

Article-No.: 006.13.126

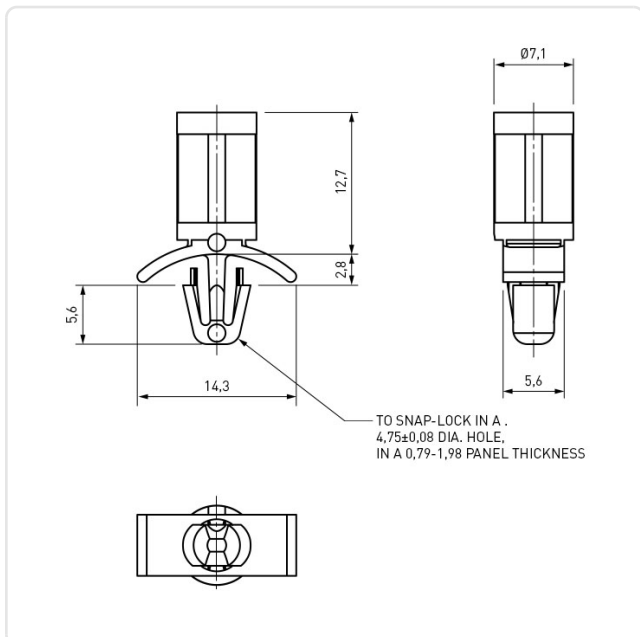

Image may be similar

Color: Natural
Flammability Class: UL94-V2
Length [mm]: 12.7
Material: PA 6.6
Material Group: Plastic
Panel Hole \varnothing [mm]: 4.8
Panel Thickness [mm]: 0,8-2,0
Weight: 0.48g
Conformities:



You can find all information on the web on our article detail page



Would you like individual advice?

We look forward to your email to products@ettinger.de.

Subject to change and errors.