

Article datasheet

## Interlocking Hose Clamp Ø6.6-8.0 Polyamide 6.6 black

Article-No.: 014.44.080

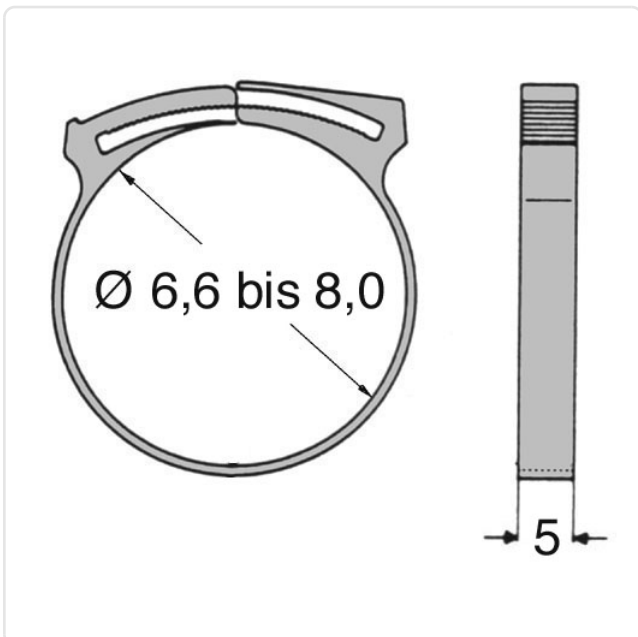

Image may be similar

Color:	Black
Flammability Class:	UL94-V2
Material:	PA 6.6
Panel Thickness Range [mm]:	6,6-8,0
Thickness [mm]:	1.8
Width [mm]:	5
Weight:	0.83g
Conformities:	



You can find all information on the web on our article detail page



Would you like individual advice?

We look forward to your email to [products@ettinger.de](mailto:products@ettinger.de).

Subject to change and errors.