

Article datasheet

## PCB Support 12.7 | $\varnothing 4.8$ | $\varnothing 3.3$ Polyamide 6.6 natural

Article-No.: 006.79.212

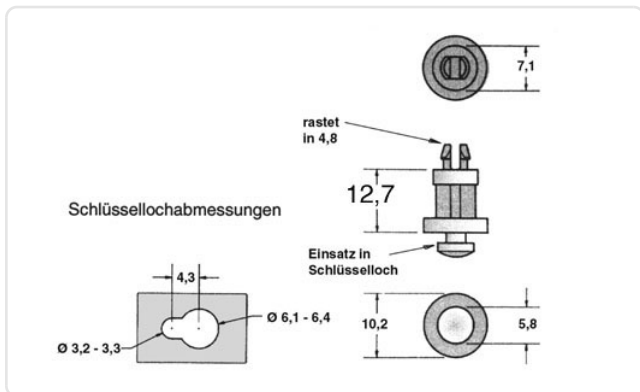

Image may be similar

Color:	Natural
Flammability Class:	UL94-V2
Length [mm]:	12.7
Material:	PA 6.6
PCB Hole $\varnothing$ [mm]:	4.8
PCB Thickness [mm]:	1,6
Panel Hole $\varnothing$ [mm]:	6.4
Panel Thickness [mm]:	1,6
Conformities:	



You can find all information on the web on our article detail page



Would you like individual advice?

We look forward to your email to [products@ettinger.de](mailto:products@ettinger.de).

Subject to change and errors.