

Article datasheet

## Weld Nut DIN929 M6 A4 Plain Stainless Steel Hexagon

Article-No.: 002.31.069

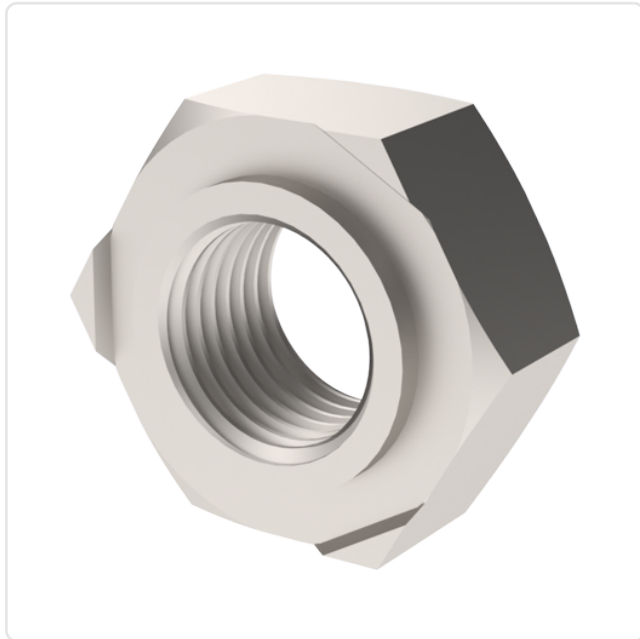
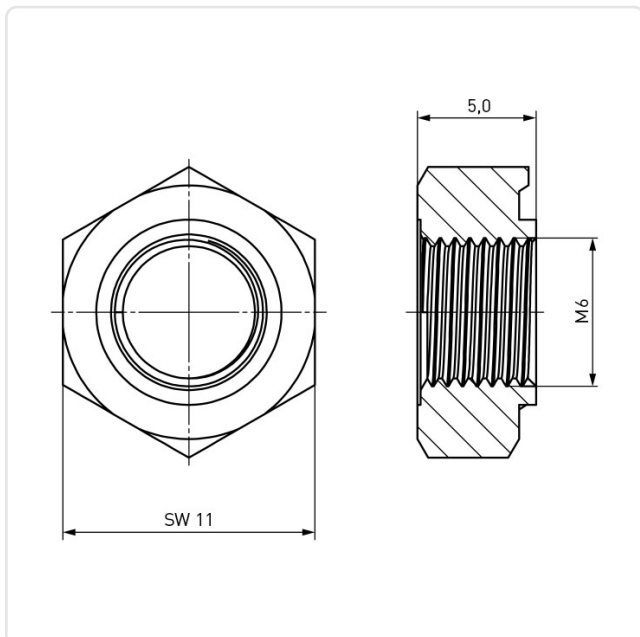

Image may be similar

AF / OD [mm]: 11  
DIN/ISO: DIN929  
Finish: Plain  
Height [mm]: 5  
Material: Stainless Steel AISI 316 / A4  
Thread Size: M6  
Conformities:



You can find all  
information on the web on  
our article detail page



Would you like individual advice?

We look forward to your email to [products@ettinger.de](mailto:products@ettinger.de).

Subject to change and errors.