

Article datasheet

Flanged Bearing $\varnothing 40/46/55 \times 46$ -3mm Polyamid 6.6 natural

Article-No.: 005.99.406

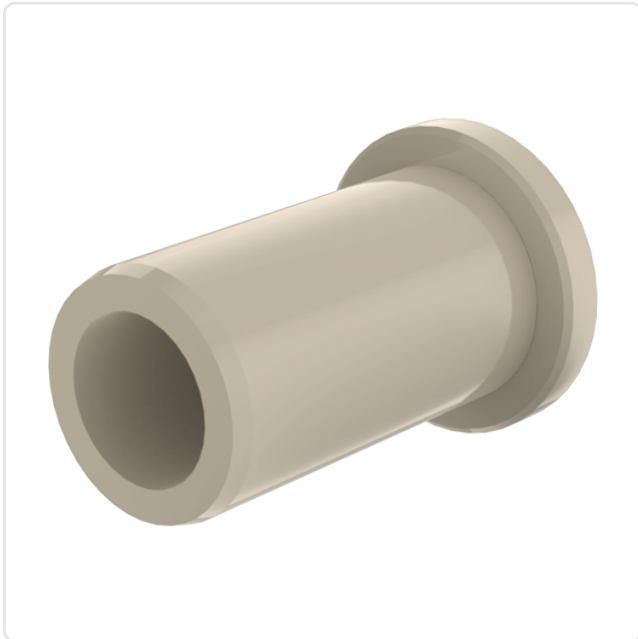

Image may be similar

Color: Natural
Flammability Class: UL94-V2
Inner Diameter [mm]: 40
Length [mm]: 46
Lug Diameter [mm]: 46
Material: PA 6.6
Material Group: Plastic
Model: With High Lug
Outer Diameter [mm]: 55
Weight: 22.8g
Conformities:



You can find all information on the web on our article detail page

Would you like individual advice?

We look forward to your email to products@ettinger.de.

Subject to change and errors.

