

Article datasheet

Thread Forming Screw DIN7500M M3x6 A2 Plain Stainless Steel Torx CSK

Article-No.: 001.36.322



Image may be similar

Actuator Size:	Torx T10
DIN/ISO:	DIN7500-M
Drive Type:	TORX
Finish:	Plain
Head Diameter [mm]:	5.6
Head Height [mm]:	1.65
Head Shape:	Countersunk Head
Length [mm]:	6
Material:	Stainless Steel AISI 304 / A2
Material Group:	Stainless Steel
Thread Size:	M3
Thread Type:	Metric
Weight:	0.32g
Conformities:	

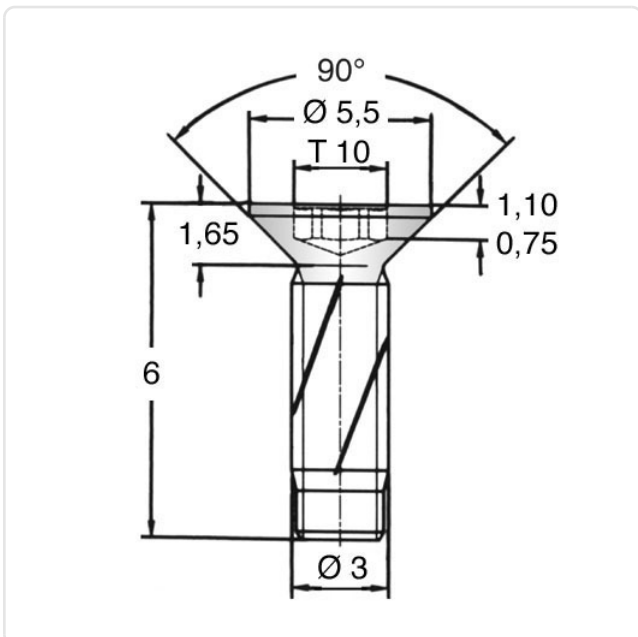

You can find all information on the web on our article detail page

Would you like individual advice?

We look forward to your email to products@ettinger.de.

Subject to change and errors.