

Article datasheet

Knurled Nut M7x0.75 Anodized Aluminum

Article-No.: 062.07.107

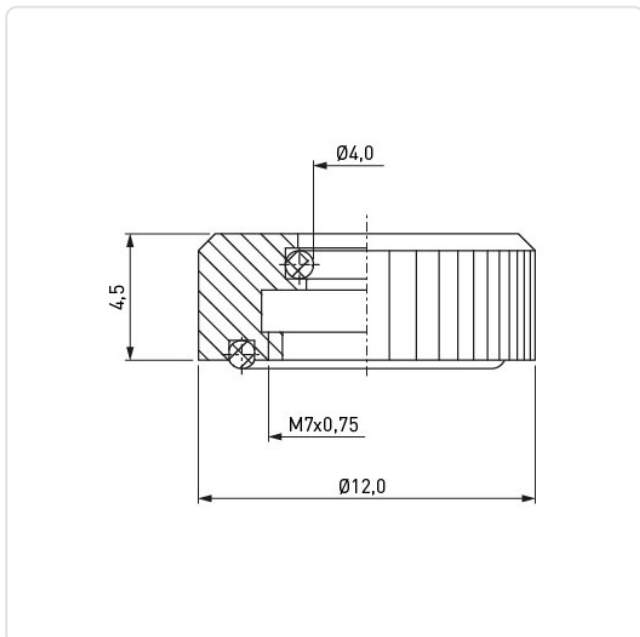

Image may be similar

AF / OD [mm]: 12
Finish: Anodized, Clear
Height [mm]: 4.5
Material: Aluminum ENAW-6060 / AlMgSi, lead-free
Material Group: Aluminum
Thread Size: M7x0.75
Weight: 0.92g
Conformities:



You can find all
information on the web on
our article detail page



Would you like individual advice?

We look forward to your email to products@ettinger.de.

Subject to change and errors.