

Article datasheet

IEC Power Fused Inlet Snap-in 1-3mm 10A/250V fuses 5x20 6.3x0.8mm terms

Article-No.: 044.50.002

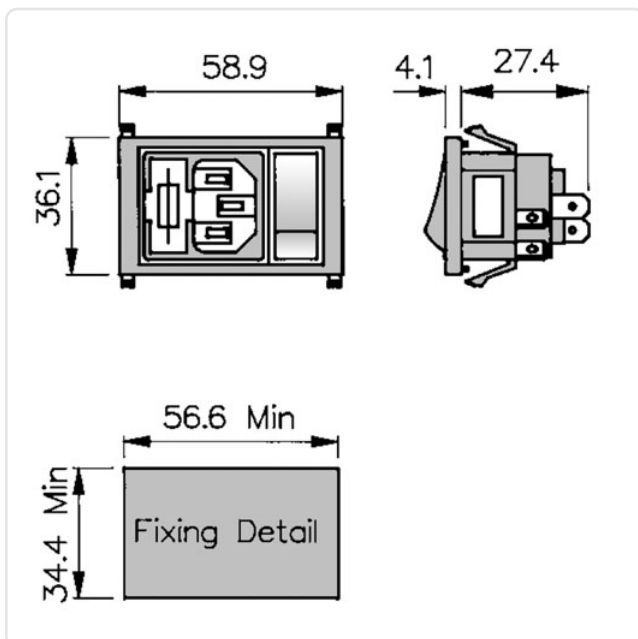

Image may be similar

Amperage [A]: 10
Color: Black
Connections: 6.3x0.8
Fuse Size [mm]: 5.0x20.0
Model: Plug, Snap-In Mounting
Weight: 35.7g
Conformities:



You can find all information on the web on our article detail page



Would you like individual advice?

We look forward to your email to products@ettinger.de.

Subject to change and errors.