

Article datasheet

## Long Nut M5 DIN6334 A4 Stainless Steel AF 8x15 / M5

Article-No.: 002.20.059

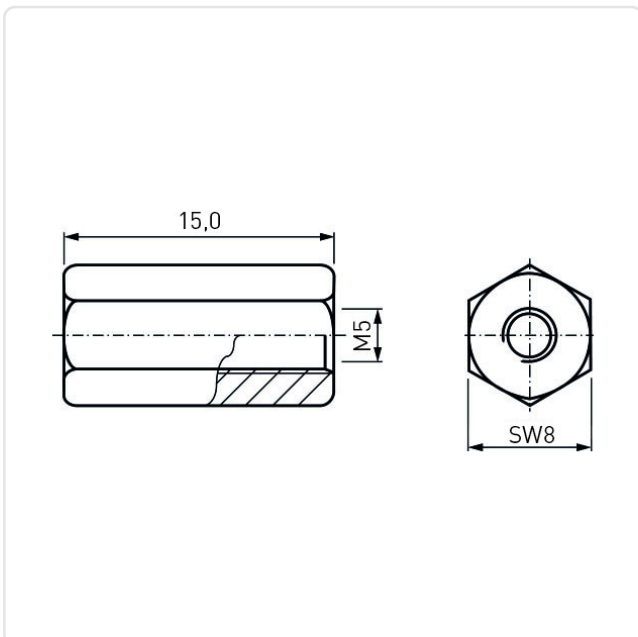

Image may be similar

DIN/ISO: DIN6334  
Finish: Plain  
Length [mm]: 15  
Material: Stainless Steel AISI 316 / A4  
Material Group: Stainless Steel  
Profile: Hexagonal  
Thread Size: M5  
Conformities:



You can find all  
information on the web on  
our article detail page



Would you like individual advice?

We look forward to your email to [products@ettinger.de](mailto:products@ettinger.de).

Subject to change and errors.