

Article datasheet

Switch Vandal Resistant Illuminated Stainless steel/1-pole/2.8x0.8mm

Article-No.: 011.11.465

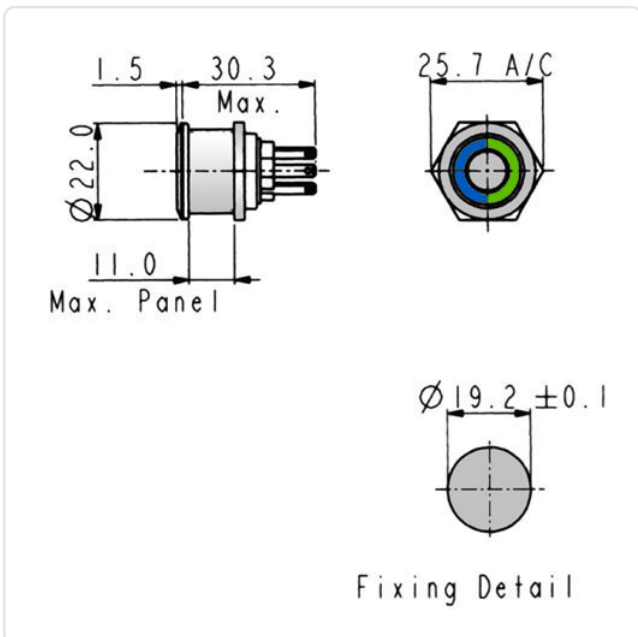

Image may be similar

Contact Plating:	Gold-plated
Diameter [mm]:	22
Material:	Stainless Steel AISI 316 / A4
Material Group:	Stainless Steel
Model:	Ring Illumination
Mounting Hole [mm]:	19.2
Protection Code:	IP66
Weight:	26.8g
Conformities:	



You can find all information on the web on our article detail page



Would you like individual advice?

We look forward to your email to products@ettinger.de.

Subject to change and errors.