

Article datasheet

Adhesive scale 0-100

Article-No.: 060.50.141

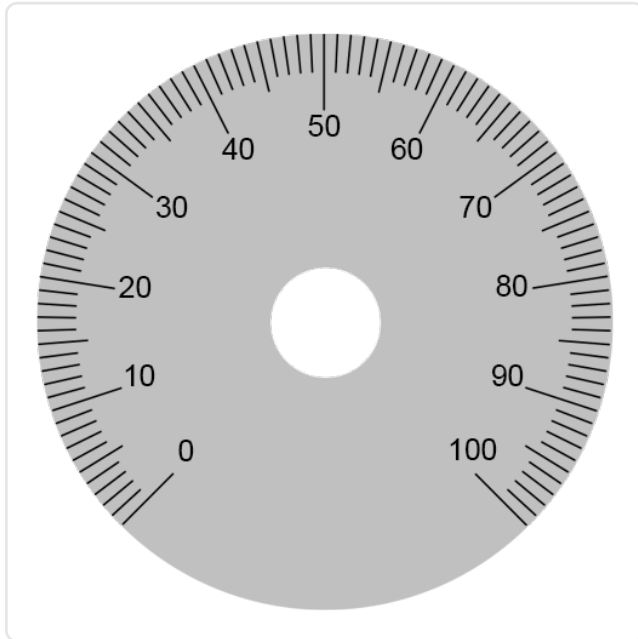
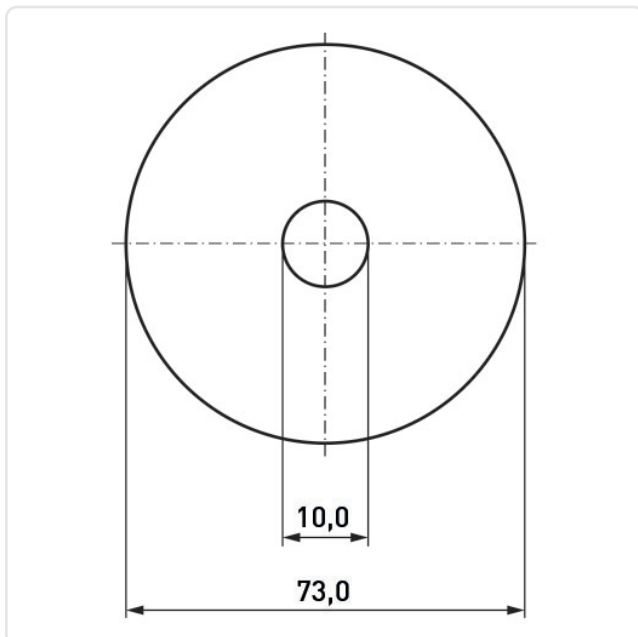

Image may be similar



Inner Diameter [mm]:	10
Marking:	0-100
Material:	Aluminum ENAW-5754 / AlMg3, lead-free
Material Group:	Aluminum
Model:	Dial
Outer Diameter [mm]:	73
Weight:	3.86g
Conformities:	



You can find all information on the web on our article detail page

Would you like individual advice?

We look forward to your email to products@ettinger.de.

Subject to change and errors.