

Article datasheet

Insulated Standoff PA-Brass M/F AF7x8 | F=M3x4 M=M3x6

Article-No.: 005.41.935



Image may be similar

AF / OD [mm]:	7
Female Thread Length [mm]:	4
Female Thread Size:	M3
Flammability Class:	UL94-HB
Length [mm]:	8
Male Thread Length [mm]:	6
Male Thread Size:	M3
Material:	PA 6.6
Material Group:	Plastic
Profile:	Hexagonal
Thread Insert Material:	Brass
Weight:	0.99g
Conformities:	

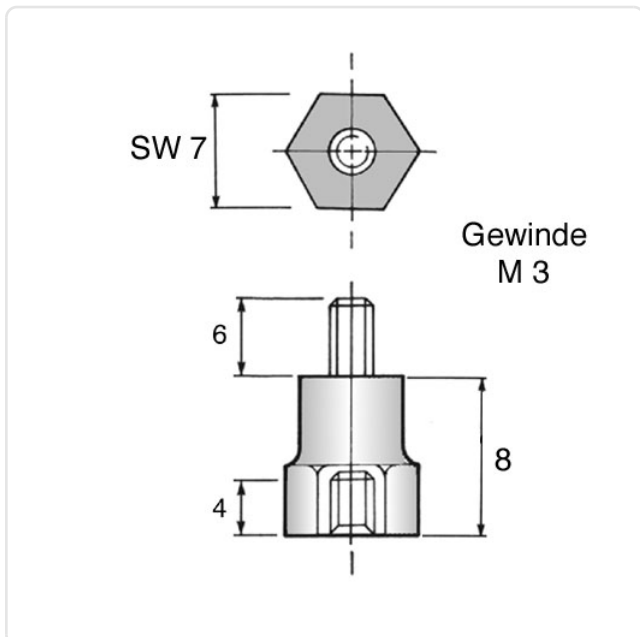

You can find all information on the web on our article detail page

Would you like individual advice?

We look forward to your email to products@ettinger.de.

Subject to change and errors.