

Article datasheet

Push-In Foot Ø5.0x4.0 NBR black

Article-No.: 017.53.101

Manufacturer: SES-Sterling

Manufacturer article-no.: 0254-0040-010

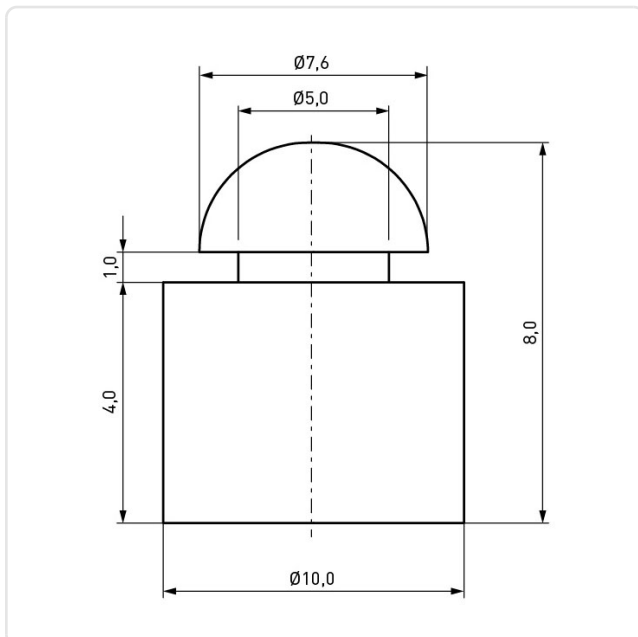

Image may be similar

Color: Black
Diameter [mm]: 5
Height [mm]: 4
Material: NBR - Nitrile Butadiene Rubber
Panel Hole Ø [mm]: 5
Panel Thickness [mm]: 1
Weight: 0.76g
Conformities:



You can find all
information on the web on
our article detail page



Would you like individual advice?

We look forward to your email to products@ettinger.de.

Subject to change and errors.