

Article datasheet

Hole Plug $\varnothing 4.6/7.0$ mm Polyethylene,natural/Not UL-listed

Article-No.: 014.10.034

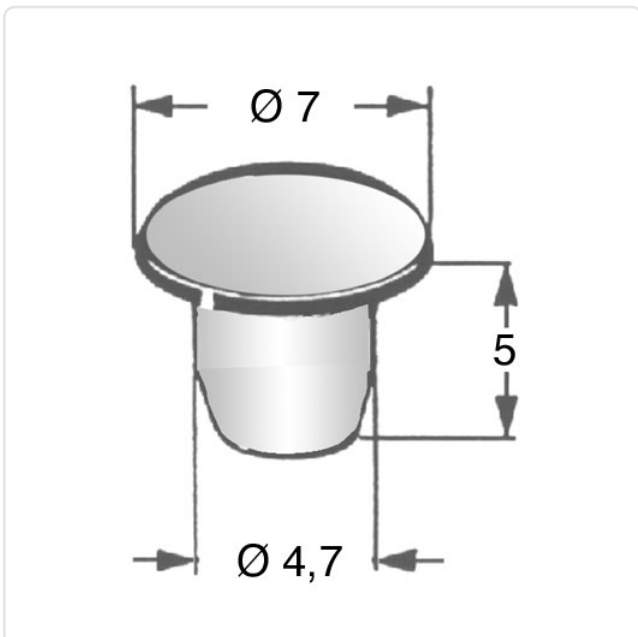

Image may be similar

Color: Natural
Inner Diameter [mm]: 4.6
Material: PE - Polyethylene
Material Group: Plastic
Model: Hole Plug
Outer Diameter [mm]: 7
Weight: 0.09g
Conformities:



You can find all
information on the web on
our article detail page



Would you like individual advice?

We look forward to your email to products@ettinger.de.

Subject to change and errors.