



Article datasheet

## Spring Washer DIN137 B $\text{\O}4.3/9.0 \times 0.5$ A2 Plain Stainless Steel

Article-No.: 003.23.049

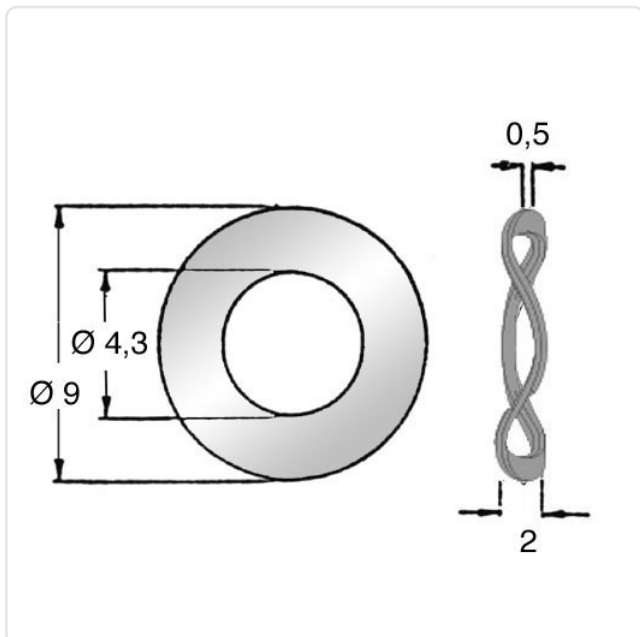

Image may be similar

DIN/ISO:	DIN137B
Finish:	Plain
For Thread Size:	M4
Height [mm]:	0.5
Inner Diameter [mm]:	4.3
Material:	Stainless Steel AISI 304 / A2
Material Group:	Stainless Steel
Outer Diameter [mm]:	9
Weight:	0.16g
Conformities:	  



You can find all information on the web on our article detail page



Would you like individual advice?

We look forward to your email to [products@ettinger.de](mailto:products@ettinger.de).

Subject to change and errors.