

Article datasheet

## PCB Support 4.8 | ø7.9 Polycarbonate natural

Article-No.: 006.25.091

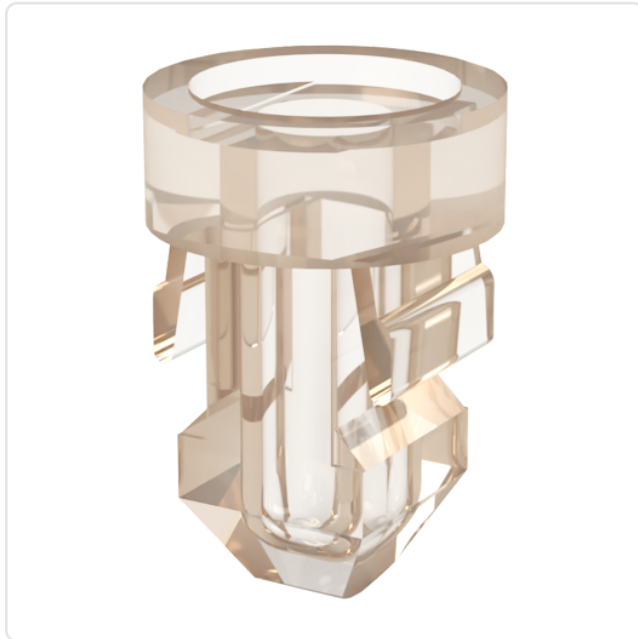
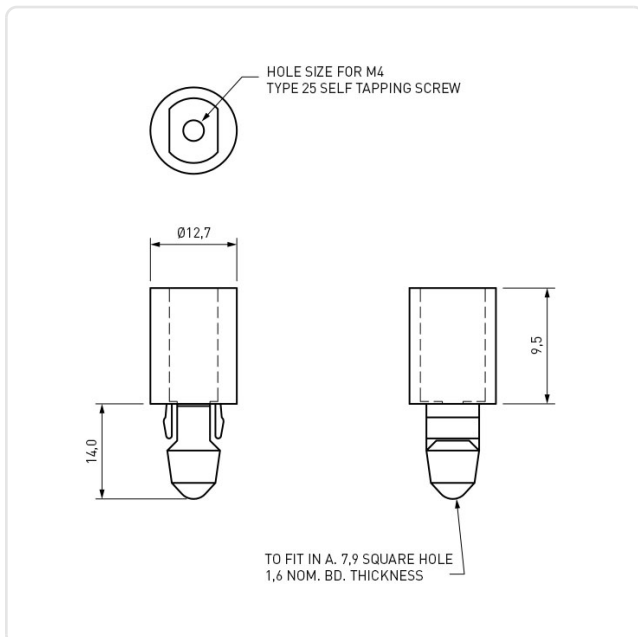

Image may be similar

Color: Natural  
Flammability Class: UL94-V2  
Length [mm]: 9.5  
Material: PC - Polycarbonate  
Material Group: Plastic  
Panel Hole Ø [mm]: 7.9  
Panel Thickness [mm]: 1,6  
Weight: 1.4g  
Conformities:



You can find all information on the web on our article detail page



Would you like individual advice?

We look forward to your email to [products@ettinger.de](mailto:products@ettinger.de).

Subject to change and errors.